



The 1st electronic relascope / dendrometer

User's Manual

2nd Edition



**LASER
TECHNOLOGY**

Redefining Measurement

Copyright Notice:

Information in this document is subject to change without notice and does not represent a commitment on the part of Laser Technology Inc. No part of this manual may be reproduced in any form or by any means, electronic or mechanical, including photocopying, recording, or information storage and retrieval systems, for any purpose other than the purchaser's personal use, without the express written consent of Laser Technology, Inc.

Copyright © Laser Technology, Inc., 2005. All rights reserved.

First Edition: June 2005

Second Edition: June 2005

Patents:

This product is covered by pending patent applications and/or the following issued U.S. Patent: 6,738,148

Trademarks:

Criterion, Impulse, and TruPulse are trademarks of Laser Technology, Inc. All other trademarks are the property of their respective owner.

LTI Contact Information:

Laser Technology, Inc.
7070 S. Tucson Way
Centennial, CO 80112 USA

Phone: 1-303-649-1000
1-800-790-7364 (USA and Canada)

Fax: 1-303-649-9710
Web Site: www.lasertech.com

Email: service@lasertech.com

Criterion RD 1000 Reference Information:

Record information about your RD 1000 in the table below.

	<i>You can find this value:</i>	<i>Value</i>
Serial Number	On the serial number sticker affixed to the RD 1000.	
Firmware Revision Number	When unit is turned ON.	
	See page 12 for more information.	
Magnification Constant	On the sticker affixed to the Magnifier.	
	See page 16 for more information.	

Criterion RD 1000 User's Manual

Table of Contents

Section 1 - Introducing the Criterion RD 1000	3
Features	3
Measurement Types	3
Unpacking your RD 1000	4
Views of the RD 1000	4
Section 2 - Quick Start	5
Section 3 - Basic Operations	6
Batteries	6
Installation	6
Low Battery Warning	7
Buttons	7
Key Pad	7
Other Buttons	8
Display Backlight	9
Edit Function	9
Error Codes	10
External LCD	11
Display Indicator Test	11
Firmware Revision Number	12
In-scope LED	12
Brightness	12
Measurement Bar Scale	13
Neck Strap	13
Section 4 - System Functions	14
Displaying Percent Slope	14
Using the Magnifier	15
Attaching the Magnifier	15
Removing the Magnifier	15
Turning the Magnification Constant ON or OFF	15
Displaying the Magnification Constant	16
Editing the Value	16
Selecting Measurement Units	16
Aligning the Tilt Sensor	17

Section 5 - Relascope Functions	18
BAF Mode	18
In/Out Mode	19
Section 6 - Dendrometer Functions	20
Diameter Mode	20
Height/Diameter Mode	22
Section 7 - Serial Data Interface	24
Data Format	24
Format Parameters	24
Impulse Settings	25
TruPulse Settings	25
Input Data String	25
Output Data String	25
Tree Diameter Download Message	26
Examples	26
Raw Inclination Download Message	27
Example	27
Section 8 - Care & Maintenance	28
Temperature Range	28
Protecting from Moisture and Dust	28
Protecting from Shock	28
Transporting	28
Cleaning	28
Testing the Display Segments	29
Storing	29
Section 9 - Specifications	30
Index	31

Section 1 - Introducing the Criterion RD 1000

Congratulations on the purchase of your Criterion RD 1000, the first electronic relascope/dendrometer. Laser Technology, Inc. (LTI) designed the RD 1000 specifically to address the real world needs of forestry professionals. The RD 1000 is primarily an optical device that provides real-time results for calculations that have to do with the BAF principle, tree height and diameter.

Features

- In-scope LED offers adjustable brightness levels and projects a measurement bar scale that represents a subtended horizontal angle. The RD 1000 uses this angular measurement and the horizontal distance to the target tree to calculate the diameter of the tree stem. The horizontal distance is the level distance between the eyepiece and the point of measurement on the face of the tree. To enter the horizontal distance to the target tree, you may:
 - automatically download measurement data from an LTI laser range finder.
 - measure the distance to the tree using a tape measure and then manually enter the value.
- Tilt sensor measures vertical angles, which the RD 1000 uses to determine the slope-reduced measured distance and to calculate height. The tilt sensor is capable of taking +/- 90° measurements (360° full circle).
- Attachable Magnifier can be used in situations that require maximum measurement resolution.
- Ergonomically designed for handheld use, rugged, water and dust resistant, and is small enough to carry in your vest pocket.
- Can be mounted on a tripod or monopod for increased precision.
- Works seamlessly with an LTI laser range finder and an external data collector.

Measurement Types

The RD 1000 offers five different measurements. Of these five, three produce results that may be downloaded to an external data collector.

- **BAF:** Visually estimate if trees fall "In" or "Out" of a given plot as related to the specified Basal Area Factor.
- **In / Out:** Use the internally stored plot radius factors to determine the status of a "borderline" tree.
- **Diameter:** Determine the diameter of a tree at any given height. Result may be downloaded to an external data collector.
- **Height / Diameter:** Verify the height at which a specified diameter is reached. Result may be downloaded to an external data collector.
- **Raw Inclination:** Displayed as Percent Slope. Result may be downloaded to an external data collector.

Unpacking your RD 1000

When you unpack your RD 1000, check to make sure that you have received everything that you ordered, and that it all arrived undamaged.

RD 1000 Basic Package:

- Criterion RD 1000
- Magnifier
- Batteries: AA (2) or CRV3 (1)
- Carrying Case
- Lens Cloth
- Neck Strap (and anchor)
- User's Manual

i The following items are available for use with your RD 1000. To learn more about any of these, please contact your LTI Sales Representative or an Authorized LTI Distributor.

- Serial Data Download Cable
(for use with an external data collector)
- Laser Serial Data Cable
(for use with an LTI laser range finder)
- Tripod
- Monopod

Views of the RD 1000

Figure #1 shows two different views of the RD 1000.

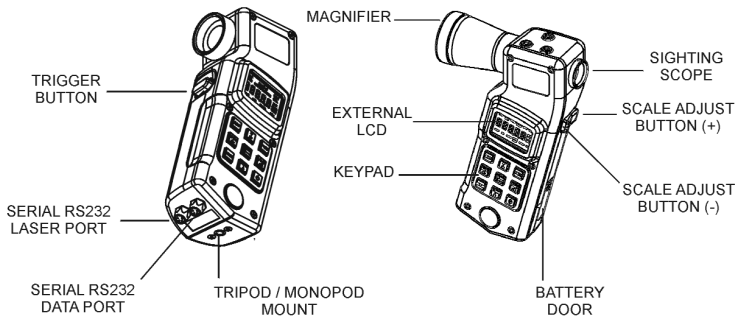



Figure #1

Section 2 - Quick Start

Now that you've unpacked and have been introduced to the RD 1000, this section will help you get started with an example of a BAF measurement. The BAF Mode is covered in more detail in Section 5 (page 18).

1. Install the batteries (page 6).
2. Press-and-hold the Power button  for a approximately 2 seconds.
3. Select the measurement units.
 - a. Press the MODE button until the external LCD displays the SYS Mode Indicator and the message "Prcnt" appears in the main display.
 - b. Press the FWD button until the external LCD displays the UNITS Status Indicator and the Unit Indicators are flashing.
Metric: M and CM Unit Indicators flashing.
Imperial:F and I Unit Indicators flashing.
 - c. Press the UP or DOWN button to toggle between Metric and Imperial Measurement Units.
4. Press the MODE button until the external LCD displays the BAF Mode Indicator, the EDIT Function Indicator, and the default (or previous) BAF value.
5. If you want to use the same BAF value, go to step #6. To enter a new BAF value, press the EDIT button and then use the arrow buttons to edit the BAF value.
 - Valid Values: 1 - 127 (Imperial) or 0.3 - 29.1 (Metric).
 - a. Press the UP or DOWN button to increase/decrease the value.
 - b. Press the FWD or BACK button to move to next/previous digit.
 - c. Press the ENTER button the accept the new BAF value.
6. Looking through the sighting scope, press-and-hold the TRIGGER button to activate the illuminated in-scope LED Measurement Bar Scale and dynamic inclination tracking. The bar scale represents the subtended horizontal angle away from the unit that corresponds to the BAF value. The scale adjusts as you aim up or down a slope.
7. Aim to the tree DBH and release the TRIGGER button. The bar scale is held and displayed in-scope LED for approximately 30 seconds.



If you are working in Imperial measurement units and want to set the BAF value to tenth's of a whole number, such as 17.5 BAF:

1. Change the measurement units to Metric (see step #3 above).
2. Return to the BAF Mode (step #5 above) and enter the metric equivalent of the Imperial BAF value that you want to use.
 - Calculate the metric equivalent by multiplying the Imperial BAF by 0.22957.
 - For the above example, $17.5 \times 0.22957 = 4.0$.
3. Continue with steps #6 and #7 above.

Section 3 - Basic Operations

Batteries

Two AA batteries are required to power the RD 1000. Instead of AA batteries, you may also use one CRV3 battery.

Installation

When installing the batteries, refer to Figure #2 and the instructions below.

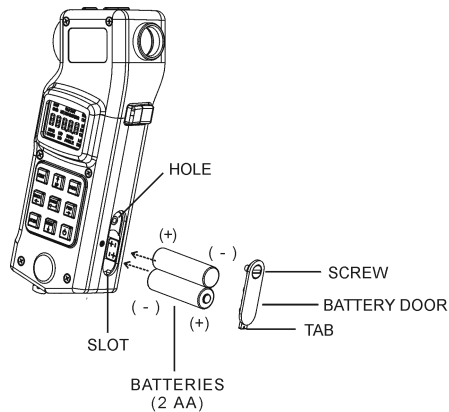

Figure #2

Removing the Battery Door:

1. Use a coin to release the screw that secures the battery door. Turn the screw counter-clockwise. The door will raise as the screw is released.
2. Once the screw is released, lift the battery door to remove.

Installing the Batteries:

1. Insert the batteries as shown in Figure #2 above.
 - Insert the lower battery negative end first.
 - Insert the upper battery positive end first.



If using one CRV3 battery, the battery compartment is designed so the battery will only fit one way.

Replacing the Battery Door:

1. Insert the tab into the slot. The screw should align with the hole.
2. Use a coin to tighten the screw. Turn the screw clockwise. The door lowers as the screw is tightened.
3. Do not over-tighten. The surface of the battery door should be level with the surrounding surface.

Low Battery Warning

The RD 1000 monitors the incoming battery voltage.

- When the voltage drops below 2.2V, the External LCD main display flashes "LobAt" every 5 seconds, alternating with the normally displayed information.
 - You should replace the batteries as soon as possible.
- When the voltage drops below 2.0V, the "LobAt" message stops flashing and is displayed steady. At this point system operation is locked.
 - You must replace the batteries to return to normal system operation.

Buttons

The RD 1000 has 11 buttons. Nine of these buttons are located on the keypad below the external LCD. The TRIGGER button is located at your index finger on the front of the unit, and the Scale Adjust button is located at your thumb on the back of the unit.

Key Pad

Figure #3 shows the keypad. The table below describes the function of each button.

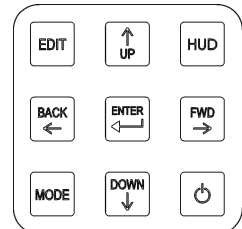

Figure #3

EDIT	Activates the edit function (page 9).
↑ UP	System Menu: Toggles value. Edit function: Increases the digit value. HUD brightness: Increases the value.
HUD	When the Heads Up Display (HUD) is active, controls the in-scope LED. Short Press: Activates the in-scope LED and displays the brightness value. Long Press: Toggles the illuminated in-scope LED Measurement Bar Scale from Solid to Gap or Gap to Solid.
BACK ←	System Menu: Moves to the previous menu item. Edit function: Moves to the previous digit (right to left). Measurement: Moves to the previous step.
ENTER ↵	Confirms function. Selects value.

- FWD** → System Menu: Moves to next menu item.
Edit function: Moves to the next digit (left to right).
- MODE** Moves through the operating modes.
- DOWN** ↓ System Menu: Toggles value.
Edit function: Decreases the digit value.
HUD brightness: Decreases the value.
Measurement result: Downloads data (page 25).
- POWER** When unit is OFF:
 - Press and hold for a minimum of 2 seconds turns ON the unit. For a brief time, all segments are displayed followed by the firmware revision number, and then the unit is ready for use.
 - Press and Hold: external LCD shows all display segments (10 seconds maximum).When unit is ON:
 - Short press turns the display backlight ON/OFF.
 - Long press (2 seconds minimum) turns OFF the unit.

i To conserve battery power, if no button presses are detected for a period of 15 minutes, the RD 1000 automatically turns itself OFF.

Other Buttons

Figure #4 shows the TRIGGER button and the SCALE ADJUST button.

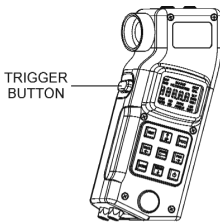

TRIGGER

Short Press: (1) Activates the in-scope LED (stays lit for 30 seconds if no additional buttons are pressed). (2) Accepts in-scope target points (such as tree base, etc.).
Press-and-hold: Activates the tilt sensor, and measurements are dynamically updated. Upon release, the inclination reading is locked.

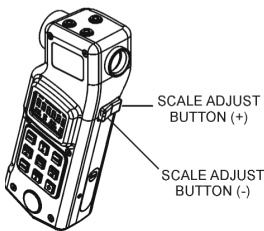

Figure #4

SCALE ADJUST (+)

Increases the width of the illuminated in-scope LED Measurement Bar Scale.

- Short Press: Increases the scale by one tick.
- Press-and-hold: Continuously increases the scale width change.

SCALE ADJUST (-)

Decreases the width of the illuminated in-scope LED Measurement Bar Scale.

- Short Press: Decreases the scale by one tick.
- Press-and-hold: Continuously decreases the scale width change.

Display Backlight

When working in low-light conditions, you may find it easier to read the external LCD if the display backlight is toggled ON. No matter what screen is displayed; the display backlight may be toggled ON or OFF using a short press the POWER button.

-  To conserve battery power, you should only use the backlight when necessary.

Edit Function

The RD 1000's edit function allows you to manually enter numeric values. The table below lists the editable values and the valid values for each value.

Editable Value	Valid Values	
	Imperial	Metric
BAF value	1 - 127	0.3 - 29.1
Diameter	0.1 - 1400.0 inches	0.3 - 3500.0 cm
Horizontal Distance (HD)	1.65 - 999.90 ft	0.51 - 304.76 m
Magnification Constant	2.00 - 2.99	

When you come across an editable value:

- System Mode: The external LCD will display the EDIT Function Indicator.
- Measurement Mode: The external LCD will display the EDIT Function Indicator and the corresponding Measurement Prompt Indicator will be flashing.

To edit a value:

1. Press the EDIT button. The active digit flashes.
2. Enter the desired value using the arrow buttons.
 - The ↑ button increases the digit value.
 - The ↓ button decreases the digit value.
 - The → button activates the next digit (left to right).
 - The ← button activates the previous digit (right to left).
3. Press the ENTER button to accept the value.
 - An E05 error code will be displayed if you attempt to enter an invalid value.

Error Codes

An error code will be displayed if the RD 1000 detects a problem with a measurement. Depending upon the current function, error codes are displayed in either the in-scope LED or the external LCD display. The table below lists and explains the possible error codes.

Code	Explanation	Remedy
E01	Unstable inclination value. The instrument is too unsteady to produce an accurate reading.	<ul style="list-style-type: none"> Steady the instrument before releasing the TRIGGER button.
E02	Calculation error. There was an error in performing an internal calculation caused by improper measurement geometry. Likely caused by a incorrectly entered data value, or an incorrect target shot from an external laser device.	<ul style="list-style-type: none"> Re-enter or re-shoot the data.
E03	Data communication error. There was an error in a received serial data string from an external device.	<ul style="list-style-type: none"> Verify that the laser and the RD 1000 are using the same units. Verify the laser mode (it should be in HD or VD) and re-shoot.
E04	System memory error. There was some type of failure of the internal system memory. This represents a memory checksum failure of factory stored parameters.	<ul style="list-style-type: none"> If the error persists, contact Laser Technology, Inc.
E05	Data entry error. An improper value was entered during a manual data edit operation (the entered data was outside of acceptable value limits).	<ul style="list-style-type: none"> Check value and re-enter data.
E06	Unable to display the input value in the in-scope LED or external LCD.	<ul style="list-style-type: none"> Re-enter data. Hold the instrument within tilt limits.
	Unable to display the calculated value.	<ul style="list-style-type: none"> Press the ENTER button to continue with the calculation.

External LCD

Figure #5 shows the external LCD. You will notice that the main display is located at the center of the screen and that display indicators are grouped by type.

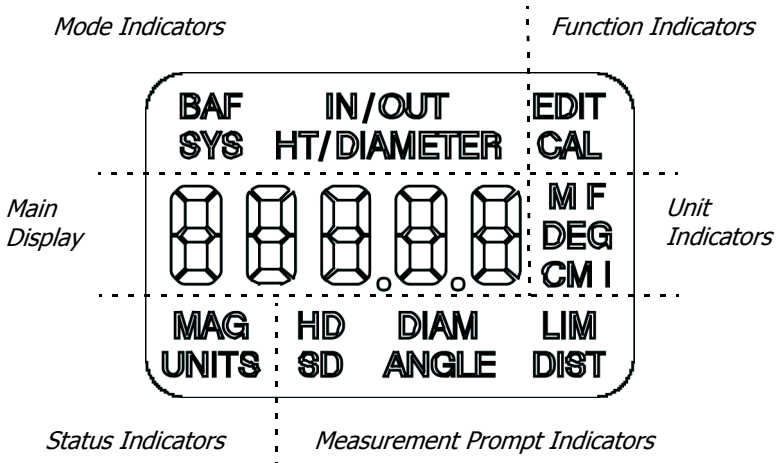

Figure #5

Display Indicator Test

Refer to the instructions below and Figure #5 above to verify that all display indicators are working properly.

1. Starting with the unit powered OFF, press and hold the POWER button.
2. Verify that all indicators are displayed, by comparing the display to the Figure #5 above.
3. Release the POWER button to start normal operation.
 - If you do not release the POWER button, the unit will power down after approximately 10 seconds.

Firmware Revision Number

The firmware revision number provides manufacturing information about your RD 1000. Each time the RD 1000 is powered ON, the external LCD displays the firmware revision number, "r 1.xx" (where 'xx' is a value from 00 to 99).

In-scope LED

When the Heads Up Display (HUD) is active, the HUD button controls the in-scope LED.

- Short Press: Activates the in-scope LED and displays the brightness value for approximately 3 seconds.
- Long Press: Toggles the illuminated in-scope LED between Measurement Bar Scale between Solid Mode and Gap Mode.

Brightness

To accommodate working in different lighting conditions, you may adjust the brightness level of the in-scope LED. The brightness value is stored in memory. The last value used is maintained when the unit is powered ON. Refer to the instructions below to display and change the brightness value.

1. Press the HUD button to activate the in-scope LED. Both the in-scope LED and external LCD display the brightness value as "br X".
 - Where 'X' is a value from 1 to 7.
2. Press the UP button to increase the value.
3. Press the DOWN button to decrease the value.
 - The unit will return to normal system operation approximately 3 seconds after the last button press.

Measurement Bar Scale

Figure #6 shows the two Measurement Bar Scale modes: Solid and Gap. The Measurement Bar Scale mode is stored in memory, the last mode used is maintained when the unit is powered on.



Solid Bar Scale



Gap Bar Scale

Figure #6

Refer to the instructions below to change the Measurement Bar Scale mode.

1. Long press the HUD button to toggle to the other scale. A message corresponding to the new scale "GAP" or "SLd" is displayed in both the in-scope LED and external LCD display .
 - The unit will return to normal system operation approximately 3 seconds after the last button press.

i In most situations, you will find that the Solid Bar Scale works best in the BAF Mode, and that the Gap Bar Scale works best in the Diameter and Height/Diameter Modes.

Neck Strap

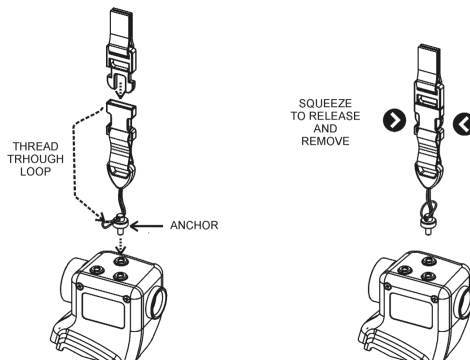

Figure #7

Section 4 - System Functions

Figure #8 shows an overview of the System functions. To select the System Mode, press the MODE button until the external LCD displays the SYS Mode Indicator and the message "Prcnt" appears in the main display. The SYS Mode indicator is displayed when the System Mode is active. Press the FWD button or BACK button to move between the functions.

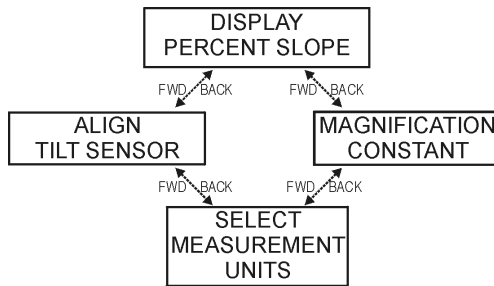

Figure #8

Displaying Percent Slope

The RD 1000's tilt sensor allows you to view inclination values. Values are displayed in the in-scope LED and appear as whole units of percent slope.

$$\text{Percent Slope} = (\tan \theta) \times 100$$

1. Press the MODE button until the external LCD displays the SYS Mode Indicator and the message "Prcnt" appears in the main display.
2. Looking through the sighting scope, press-and-hold the TRIGGER button to activate the tilt sensor. The horizontal aiming marks and the percent slope appear in the in-scope LED.
 - a. The value updates as long as you hold the TRIGGER button.
 - b. When you release the TRIGGER button, the percent slope is locked and is displayed in the in-scope LED for a maximum of 30 seconds (if no other buttons are pressed).
 - c. To download a serial data string through the serial port to an external data collector, press the DOWN button.
 - The serial data string contains the raw inclination, it does not contain the percent slope (page 27).
3. Press-and-hold the TRIGGER button to repeat this process.
 - Press the FWD button to move to the next System function.
 - Press the BACK button to move to the previous System function.
 - Press the MODE button to select a measurement mode.

Using the Magnifier

When your work requires maximum measurement resolution, you will want to attach the Magnifier to the RD 1000 and turn ON the magnification constant. The Magnifier modifies the subtended angle represented in the in-scope LED Measurement Bar Scale, covering an overall smaller range of angles. Thereby increasing the individual bar 'tick' resolution. You should note that the Magnifier has no practical use in the BAF Mode.

Each Magnifier is labelled with its own unique magnification constant. The magnification constant is stored in RD 1000's memory. The constant must be toggled ON when the magnifier is attached to the RD 1000, and toggled OFF when the magnifier is not attached to the RD 1000. The external LCD displays the MAG Status Indicator when the Magnification Constant is toggled ON. As long as you are using the Magnifier that shipped with your RD 1000, you should not ever have to change the value of the constant.

Attaching the Magnifier

1. Grasp the magnifier by the front, outside edges opposite the threads.
2. Position the magnifier front of the RD 1000 as shown in Figure #9 so the threads are aligned.
3. Turn the magnifier clockwise to secure to the RD 1000. Do not force the first few turns and tighten until snug.

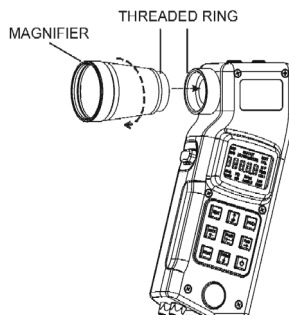

Figure #9

Removing the Magnifier

1. Grasp the magnifier by the front, outside edges.
2. Turn the magnifier counter-clockwise.

Turning the Magnification Constant ON or OFF

1. Press the MODE button until the external LCD displays the SYS Mode Indicator.
2. Press the FWD or BACK button until the MAG Status Indicator is displayed and "OFF" or "On" appears in the main display.
3. Press the UP or DOWN button to toggle the selection.
 - Press the FWD button to move to the next System Option.
 - Press the BACK button to move to the previous System Option.
 - Press the MODE button to select a measurement mode.

Displaying the Magnification Constant

1. Press the MODE button until the external LCD displays the SYS Mode Indicator.
2. Press the FWD or BACK button until the MAG Status Indicator is displayed and "OFF" or "On" appears in the main display.
 - If "OFF" is displayed, press the UP or DOWN button to toggle "ON".
3. Press and hold the EDIT button for approximately 3 seconds. The current Magnification constant appears in the main display. This value should match the number that appears on the magnifier.
 - If you want to use the same Magnification Constant, press the MODE button to select a measurement mode.
 - See below to edit the value of the Magnification Constant.
 - Press the FWD button to move to the next System Option.
 - Press the BACK button to move to the previous System Option.

Editing the Value

1. Display the Magnification Constant (see above).
2. Press the EDIT button and use the arrow buttons to edit the value.
 - Valid Values: 2.00 to 2.99.
 - a. Press the UP or DOWN button to increase/decrease the value.
 - b. Press the FWD or BACK button to move to next/previous digit.
 - c. Press the ENTER button to accept the new Magnification constant.
 - Press the MODE button to select a measurement mode.
 - Press the FWD button to move to the next System Option.
 - Press the BACK button to move to the previous System Option.

Selecting Measurement Units

The RD 1000 allows you to choose between Metric and Imperial measurement units. Refer to the instructions below to toggle the selection.

1. Press the MODE button until the external LCD displays the SYS Mode Indicator.
2. Press the FWD or BACK button until the Units Status Indicator and distance measurement Unit Indicators (flashing) are displayed.
3. Press the UP or DOWN button to toggle between Imperial and Metric Units.
 - Metric:** M and CM flashing. **Imperial:** F and I flashing.
 - Press the FWD button to move to the next System option.
 - Press the BACK button to move to the previous System option.
 - Press the MODE button to select a measurement mode.

- i** When using an LTI laser range finder with your RD 1000, you should verify that you have selected the same measurement units in both instruments. If the RD 1000 and the laser are not using the same measurement units, the RD 1000 will convert the measurement data received from the laser. For example, if the RD 1000 is using *Imperial units*, and the laser is using *Metric units*, the RD 1000 will convert the measurement data received from the laser to *Imperial units*.

Aligning the Tilt Sensor

In the rare event that the unit suffers a severe drop shock, refer to the instructions below to align the tilt sensor.

1. Press the MODE button until the external LCD displays the SYS Mode Indicator.
2. Press the FWD or BACK button until the CAL Function Indicator is displayed and the message "rEF 1" appears in the main display.
3. Position the RD 1000 on a flat, relatively level surface as shown in Figure #10(A).
 - Do not lift or raise the unit until the message "dOnE" is displayed in step #6 below.

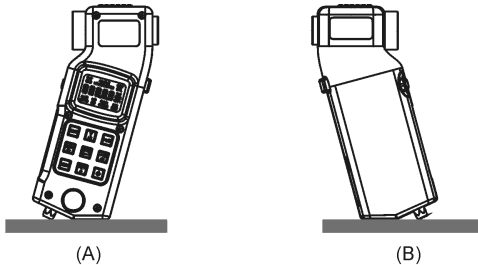

Figure #10

4. Press the ENTER button to store the inclination measurement. The message "rEF 2" appears in the main display.
5. Slowly rotate the RD 1000 180 degrees as shown in Figure #10(B).
6. Press the ENTER button to store the inclination measurement and make the zero offset correction. The message "dOnE" appears in the main display before the message "ref 1" is displayed.
 - Press the FWD button to move to the next System option.
 - Press the BACK button to move to the previous System option.
 - Press the MODE button to select a measurement mode.

Section 5 - Relascope Functions

- **BAF Mode:** Specify a Basal Area Factor value and visually estimate if trees fall "In" or "Out" of a given plot.
- **IN/OUT Mode:** Use the internally stored plot radius factors to determine the status of "borderline" trees.

BAF Mode

Refer to the instructions below to complete a BAF measurement.

1. Press the MODE button until the external LCD displays the BAF Mode Indicator, the previously entered (or default) BAF value, and the EDIT Function Indicator. This is prompting you to enter a different BAF value.
 - If you want to use the same BAF value, go to step #3.
 2. To enter a different BAF value, press the EDIT button and then use the arrow buttons to edit the value.
 - Valid Values: 1 - 127 (Imperial) or 0.3 - 29.1 (Metric).
 - a. Press the UP or DOWN button to increase/decrease the value.
 - b. Press the FWD or BACK button to move to next/previous digit.
 3. Press the ENTER button to accept the BAF value. Looking through the sighting scope, press-and-hold the TRIGGER button to activate the illuminated in-scope LED Measurement Bar Scale and dynamic inclination tracking. The bar scale represents the subtended horizontal angle away from the unit that corresponds to the specified BAF value. The scale automatically adjusts as you aim up or down a slope. The BAF value is also displayed in the in-scope LED numeric field.
 4. Aim to the tree DBH and release the TRIGGER button.
 - The tilt sensor is only activated when the TRIGGER button is pressed and held. As long as you hold the TRIGGER button, the tilt sensor continues to operate and update the displayed data.
 - When you release TRIGGER button, the bar scale is held and displayed in the in-scope LED for approximately 30 seconds.
-  • Repeat the above steps to take another BAF measurement.
- In most situations, you will find that the Solid Bar Scale works best in the BAF Mode. However, you can toggle the illuminated in-scope LED measurement scale from Solid to Gap ([page 13](#)).
 - The Magnifier has no practical use in this mode.
 - If you are working in Imperial measurement units and want to set the BAF value to tenth's of a whole number, refer to the example on [page 5](#).

In/Out Mode

Refer to the instructions below to determine the status of "borderline" trees using the internally stored plot radius factors.

1. Press the MODE button until the external LCD displays the IN/OUT Mode Indicator, the DIAM Measurement Prompt Indicator (blinking), the appropriate Units Indicator ("CM" or "I") and the EDIT Function Indicator. This is prompting you to enter a new diameter value.
 - If you have logged a previous diameter value measured in the Diameter operating mode, this value is displayed in the external LCD.
 - If you want to use the same diameter value, go to step #3.
2. To enter a different diameter value, press the EDIT button and then use the arrow buttons to edit the value.
 - Valid Values: 0.1 - 1400.0 inches or 0.3 - 3500.0 cm.
 - a. Press the UP/DOWN button to increase/decrease the value.
 - b. Press the FWD/BACK button to move to next/previous digit.
 - c. Press the ENTER button to accept the new diameter value.
3. Based upon the diameter value that you entered, the external LCD displays the Limiting Distance. Press the ENTER button to accept the Limiting Distance value. (An E06 error code will be displayed if the Limiting Distance is too large to display. Press the ENTER button to continue with the calculation). The EDIT Function Indicator should be displayed and the HD Measurement Prompt Indicator should be blinking; prompting you to enter the horizontal distance to the target tree.
 - Valid Values: 1.65 - 999.90 feet or 0.51 - 304.76 meters.
 - To automatically fill-in: Aim and fire your LTI laser to download the measured HD value into the numeric display. The display will automatically advance to the next step.
 - To manually enter: Measure the distance using a tape measure, press the EDIT button, and use the arrow buttons to edit the value.
 - a. Press the UP/DOWN button to increase/decrease the value.
 - b. Press the FWD/BACK button to move to next/previous digit.
 - c. Press the ENTER button to accept the HD value.
 - If you want to re-enter the horizontal distance (either manually or with a laser), press the BACK button and enter a new HD value.

Directly following manual entry of the horizontal distance, or receipt of the laser serial data string, the external LCD should indicate if the measured tree is "In" or "Out" of the plot.

Section 6 - Dendrometer Functions

- **Diameter Mode:** Acquire a direct read-out of the height and diameter of a tree at any point (or multiple points) along the stem.
- **HT/Diameter Mode:** Determine the height at which a specific target diameter is reached.

Diameter Mode

Refer to the instructions below to acquire a direct read-out of the height and diameter of a tree at any point (or multiple points) along the stem — from any convenient distance away.

1. Press the MODE button until the external LCD displays the DIAMETER Mode Indicator, the HD Measurement Prompt (flashing), the appropriate Units Indicator ("F" or "M"), and the EDIT Function Indicator. This is prompting you enter the horizontal distance to the target tree.
2. Enter the horizontal distance.
 - Valid Values: 1.65 - 999.90 feet or 0.51 - 304.76 meters.
 - To automatically fill-in: Aim and fire your LTI laser range finder to download the measured HD value into the numeric display. The display will automatically advance to the next step.
 - To manually enter: Measure the distance using a tape measure, press the EDIT button, and use the arrow buttons to edit the value.
 - a. Press the UP or DOWN button to increase/decrease the value.
 - b. Press the FWD or BACK button to move to next/previous digit.
 - c. Press the ENTER button to accept the HD value.
 - If you want to re-enter the horizontal distance (either manually or with a laser), press the BACK button and enter a new HD value.
3. The external LCD displays the DIAMETER Mode Indicator, the ANGLE Measurement Prompt Indicator (flashing), the DEG Units indicator, and the message "bASE" is prompting you to take the base angle measurement to the tree. This message is also displayed in the numeric area of the in-scope LED.
4. Looking through the sighting scope, press-and-hold the TRIGGER button to activate the illuminated in-scope LED Measurement Bar Scale.
5. Aim to the base of the target tree, and release the TRIGGER button to lock the inclination measurement.
 - The inclination appears in both the in-scope LED and the external LCD, and is continuously updated as long as you hold the TRIGGER button.

- Upon release of the TRIGGER button, the in-scope LED flashes the locked inclination measurement.
- 6. Press-and-hold the TRIGGER button again and scan up the tree from the base. Release the Trigger button at any given tree height to lock the inclination measurement, for example 4.5 feet (or 1.3 meters).
 - While you are tracking up the tree stem, the tree height is dynamically updated in both the in-scope LED and the external LCD.
 - When you release the TRIGGER button, the tree diameter is shown in both the in-scope LED and the external LCD. This value is based upon the width of the illuminated in-scope LED Measurement Scale.
 - Now use the SCALE ADJUST (+) AND (-) buttons to align the edges of the bar scale with the edges of the target tree, simultaneously changing the displayed diameter value.

Once the measured tree diameter is shown in the displays:

- To download a serial data string through the serial port to an external data collector, press the DOWN button.
 - To display the height on the tree again, or move to another height position for a diameter measurement:
 1. Press-and-hold the TRIGGER button again to activate the tilt sensor and dynamically display tree heights.
 2. Scan to the desired tree height.
 3. Release the TRIGGER button to lock the inclination measurement and show the diameter at the given tree height point.
 4. Repeat the diameter measurement step (#6) above.
-  • In most situations, you will find that the Gap Bar Scale works best in the Diameter Mode. However, you can toggle the illuminated in-scope LED measurement scale from Solid to Gap ([page 13](#)).
- For increased accuracy at further distances from the tree, attach the Magnifier ([page 15](#)).

Height/Diameter Mode

Refer to the instructions below to determine the height along the stem at which a specific diameter is reached.

1. Press the MODE button until external LCD displays the HT/DIAMETER Mode Indicator, the HD Measurement Prompt Indicator (flashing), the appropriate Units Indicator ("F" or "M") and the EDIT Function Indicator. This is prompting you enter the horizontal distance to the target tree.
2. Enter the horizontal distance.
 - Valid Values: 1.65 - 999.90 feet or 0.51 - 304.76 meters.
 - To automatically fill-in: Aim and fire your LTI laser range finder to download the measured HD value into the numeric display. The display will automatically advance to the next step.
 - To manually enter: Measure the distance using a tape measure, press the EDIT button, and use the arrow buttons to edit the value.
 - a. Press the UP or DOWN button to increase/decrease the value.
 - b. Press the FWD or BACK button to move to next/previous digit.
 - c. Press the ENTER button to accept the HD value.
 - If you want to re-enter the horizontal distance (either manually or with a laser), press the BACK button and enter a new HD value.
3. The external LCD displays the HT/DIAMETER Mode Indicator, the ANGLE Measurement Prompt Indicator (flashing), the DEG Units Indicator, and the message "bASE" is prompting you to take the base angle measurement to the tree. This message is also displayed in the numeric area of the in-scope LED.
4. Looking through the sighting scope, press-and-hold the TRIGGER button to activate the illuminated in-scope LED Measurement Bar Scale.
5. Aim to the base of the target tree. When the desired base angle target point is identified, release the TRIGGER button to lock the inclination measurement.
 - The inclination appears in both the in-scope LED and the external LCD, and is continuously updated as long as you hold the TRIGGER button.
 - Upon release of the TRIGGER button, the in-scope LED flashes the locked inclination reading.
6. The external LCD displays the DIAM Measurement Prompt Indicator (flashing), the appropriate Units Indicator ("I" or "CM"), and the EDIT Function Indicator prompting you to enter a diameter value. Enter or edit the diameter value.
 - Valid Values: 0.1 - 1400.0 inches or 0.3 - 3500.0 cm.

- If a previous diameter value was measured in the Diameter Mode, this value will appear in the main display. If you want to use this diameter value, go to step #7.
- To manually enter, press the EDIT button and use the arrow buttons to edit the value.
 - a. Press the UP or DOWN button to increase/decrease the value.
 - b. Press the FWD or BACK button to move to next/previous digit.
- 7. Press the ENTER button to accept the diameter value.
- 8. Press-and-hold the TRIGGER button to activate the tilt sensor and track up the tree from the base.
 - The tree height is dynamically updated in both the in-scope LED and the external LCD.
- 9. When the horizontal aiming marks align with the edges of the target tree, release the TRIGGER button to lock the inclination measurement.
 - The tree height is shown in both the in-scope LED and external LCD.
 - To re-check or re-position the height measurement point, press and hold the TRIGGER again to activate the tilt sensor and view the updated height measurement.

Once the desired tree height is showing in the displays:

- To download a serial data string through the serial port to an external data collector, press the DOWN button. The external LCD displays the DIAM Measurement Prompt Indicator (see step #6).
- ① • In most situations, you will find that the Gap Bar Scale works best in the Height/Diameter Mode. However, you can toggle the illuminated in-scope LED measurement scale from Solid to Gap ([page 13](#)).
- In some situations, you may want to attach the Magnifier ([page 15](#)).

Section 7 - Serial Data Interface

The RD 1000's two serial ports are used to communicate with external devices. The Laser Port is a dedicated interface to an LTI laser, and the Data Port is a dedicated interface to an external data collector. The accessories needed for downloading measurement data are available from LTI or an Authorized LTI Distributor.

The serial data interface uses RS232 voltage levels and transfers information in an ASCII, hexadecimal format. Figure #11 shows the pin-out assignments for the RD 1000's two serial port connectors.

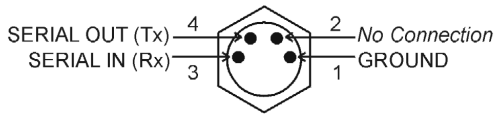

Laser Port Connector

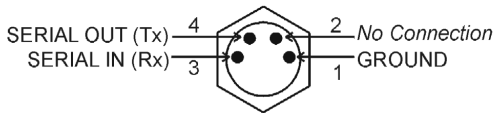

Data Port Connector

Figure #11

Data Format

The RD 1000 uses the Criterion 400 data format.

Format Parameters

- Baud rate 4800 BPS
- Start bit 1
- Data bit 8
- Stop bit 1
- Parity None

Impulse Settings

When an Impulse laser is connected to the Laser Port, the Data Port echoes out any serial data strings that come in from the laser.

1. Set Auto Download to ON.
2. Set the download format to CR400. The RD 1000 cannot communicate with the Impulse in the Impulse native data format.
3. Select the measurement mode: HD or VD.

i If your Impulse is Revision 1.43 or newer, determine if you want the Impulse to automatically output valid measurements only, or to output data strings that may contain null data from error conditions, by using the Err system setting. You need only be concerned with the Err setting if you are using the Impulse in automatic download mode. If you need more information about Impulse revision number or the Err system setting, refer to the user's manual that shipped with your Impulse.

TruPulse Settings

When a TruPulse laser is connected to the Laser Port, the Data Port echoes out any serial data strings that come in from the laser.

1. Select the measurement mode: HD or VD.

i The CR400 serial string data is automatically downloaded once a shot is taken.

Input Data String

The RD 1000 only responds to an incoming CR400 data string that contains a horizontal distance value (horizontal vector data string). For more information about this data string, refer to the user's manual that shipped with your LTI laser.

Output Data String

The RD 1000 generates and outputs two data strings, Horizontal Vector (HV message type) and Tree Diameter (DA message type). Measurement results may be downloaded in the following situations:

- Diameter result
- Height/Diameter result
- Locked raw inclination value measured in Percent Slope

Tree Diameter Download Message

Diameter results and Height/Diameter results are downloaded as a Tree diameter message and have the following format:

\$PLTIT,DA,height,ht units,diameter,d units*checksum <CR><LF>

\$PLTIT	Criterion 400 message identifier.
DA	Tree diameter message type.
<i>height</i>	Height from base.
<i>ht units</i>	Height units. F = feet M = meters
<i>diameter</i>	Diameter at height.
<i>d units</i>	Diameter units. I = inches C = centimeters
checksum	Asterisk followed by a hexadecimal checksum. Calculated by XORing all the characters between the '\$' and the ''.
<CR><LF>	Carriage return / line feed combination.

Examples

Imperial: \$PLTIT,DA,12.49,F,15.04,I*7D

Metric: \$PLTIT,DA,22.02,M,10.00,C*71

Raw Inclination Download Message

Although the RD 1000 displays raw inclination measurements as Percent Slope (page 14), locked values are downloaded as angles and only have the following format:

\$PLTIT,HV,horiz dist,units,az,units,inc,units,sd,units*checksum<CR><LF>

\$PLTIT	Criterion 400 message identifier.
HV	Horizontal Vector message type.
<i>horiz dist</i>	Horizontal distance. Always a null value.
<i>units</i>	Horizontal distance units. Always a null value.
<i>az</i>	Azimuth. Always a null value.
<i>units</i>	Azimuth units. Always a null value.
<i>inc</i>	Inclination.
<i>units</i>	Inclination units. D = degrees
<i>sd</i>	Slope distance. Always a null value.
<i>units</i>	Slope distance units. Always a null value.
checksum	Asterisk followed by a hexadecimal checksum. Calculated by XORing all the characters between the '\$' and the ''.
<CR><LF>	Carriage return / line feed combination.

Example

\$PLTIT,HV,,,,,20.31,D,,*0D

Percent Slope = $(\tan 20.31^\circ) \times 100 = 37\%$

Section 8 - Care & Maintenance

The batteries are the only user-replaceable parts in the RD 1000. Do not remove any screws, other than the screw for the battery door. To do so will effect or void the LTI Limited Warranty.

Temperature Range

The instrument components are rated for a temperature range of -22° F to +140° F (-30° C to +60° C). Do not expose the RD 1000 to temperatures outside this range.

Protecting from Moisture and Dust

The RD 1000 is sealed to provide protection from normally expected field conditions. It is protected from dust and rain, but will not withstand submersion.

If water leakage is suspected:

1. Power OFF the RD 1000.
2. Remove the batteries.
3. Air dry the RD 1000 at room temperature with the battery compartment open.

Protecting from Shock

The RD 1000 is a precision instrument and should be handled with care. It will withstand a reasonable drop shock. If the unit suffers from a severe drop shock, you may need to align the tilt sensor ([page 17](#)).

Transporting

When transporting the RD 1000 in a vehicle, the unit should be secured in the provided carrying case. The provided neck strap can be used when carrying the RD 1000 in the field.

Cleaning

Clean the RD 1000 after each use, before returning it to its carrying case. Check all of the following items:

Excess moisture. Towel off excess moisture, and air dry the instrument at room temperature with the batteries removed and the battery compartment open.

Exterior dirt. Wipe exterior surfaces clean to prevent grit buildup in the carrying case. Isopropanol may be used to remove dirt and fingerprints from the exterior.

Sighting Scope Lenses. Use the provided lens cloth to wipe the sighting scope's lenses and the external LCD. Failure to keep the lenses clean may damage them. A damaged scope lens can make it difficult to see a target.

Testing the Display Segments

It is a good idea to periodically check the external LCD to make certain that all display segments are working properly. For more information, see [page 11](#).

Storing

If you won't be using the RD 1000 again soon, remove the batteries before storing the instrument.

Section 9 - Specifications

Specifications are subject to change without notice. *Please refer to LTI's web site for current specifications.*

Dimensions:	2.75" x 2.00" x 6.5" (7 cm x 5 cm x 16.5 cm)
Weight:	1.1 pounds (500 grams)
Data Communications:	RS232, NMEA 0183, Proprietary Record Data Format
Power:	3.0 volts DC nominal.
Battery Type:	AA (2) or CRV3 (1)
Operation Duration:	AA: Approximately 20 hours. CRV3: Approximately 40 hours.
Environmental:	Water and dust resistant. NEMA 3, IP54
Operating Temperature:	-22° F to +140° F (-30° C to +60° C)
Optics:	
Normal:	1X
Magnified:	2.00 - 2.99 (value listed on the Magnifier)
Displays:	External LCD and In-scope LED
Units:	Imperial and Metric
Monopod/Tripod Mount:	¼" - 20
Measurement Range:	
BAF:	1 to 127 Ft ² /Acre (0.2 to 29.1 M ² /Hectar)
Diameter:	2" to 100" (5 cm to 254 cm) under typical field conditions.
Inclination:	+/- 90° (360° full circle)
Accuracy:	
Diameter:	±¼" (6 mm) up to 80 feet (24 m) away under typical field conditions. Maximum diameter achievable is 1400" based on the maximum allowable distance entry, but accuracy will be limited to 1% of measurement.
Inclination:	±0.1° typical
Height:	0.1 feet (0.03 m) typical

Index

A

- accessory items 4
- aligning
 - tilt sensor 17
- ANGLE measurement prompt 20, 22

B

- BACK button 7
- backlight 9
- BAF mode indicator 18
- BAF value
 - valid values 9
- bASE message 20, 22
- basic package
 - contents 4
- batteries 6
- battery door 6
- baud rate 24
- borderline trees 19
- br X message 12
- brightness value 12
- buttons 7

C

- CAL function indicator 17
- cleaning 28
- Criterion 400
 - data format 24

D

- data bit 24
- data format 24
- data port 24
- dendrometer functions 20
- DIAM measurement prompt 19, 22
- diameter
 - valid values 9
- Diameter mode 20
- DIAMETER mode indicator 20
- display backlight 9
- display indicator test 11
- DOWN button 8
- drop shock 28

E

- EDIT button 7
- edit function 9
- ENTER button 7
- error codes 10
- excess moisture 28
- exterior dirt 28
- external LCD 11

F

- firmware revision number 12
- function indicators 11
- FWD button 8

G

- gap bar scale 13
- gAP message 13

H

- HD measurement prompt 19, 20, 22
- HD. See horizontal distance
- Height/Diameter mode 22
- horizontal distance 3
 - valid values 9
- HT/DIAMETER mode indicator 22
- HUD button 7

I

- Impulse settings 25
- In/Out mode 19
- IN/OUT mode indicator 19
- input data string 25
- in-scope LED 12
- installing
 - batteries 6

K

- keypad 7

L

- laser port 24
- lenses 28
- limiting distance 19
- LobAt message 7

M

MAG status indicator 15
Magnification Constant
 display/edit value 16
 turn on/off 15
 valid values 9
magnifier 15
main display 11
measurement bar scale 13
measurement prompt indicators 11
measurement units 16
MODE button 8
mode indicators 11
moisture protection 28

N

neck strap 13

O

output data string 25

P

parity 24
percent slope 14
POWER button 8
power conservation 8, 9
Prct message 14

Q

quick start 5

R

raw inclination download message 27
rEF 1 message 17
rEF 2 message 17
relascope functions 18

S

SCALE ADJUST button 8
serial data interface 24
SLD message 13
solid bar scale 13
specifications 30
start bit 24
status indicators 11
stop bit 24
storing 29
SYS mode indicator 14
system functions 14

T

temperature range 28
tilt sensor
 aligning 17
transporting 28
tree diameter download message 26
TRIGGER button 8
TruPulse settings 25

U

unit indicators 11
units 16
UP button 7

V

views of the RD 1000 4

W

warranty 28
water leakage 28